

Data Sheet



Article number: 12515800130100

Description: KLEE-coil 515 800 130.100
M3 Hardened, zinc-pl. & chr. yellow

Measures

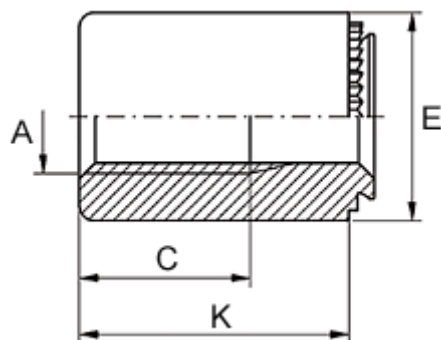

| | |
|---------------------------------|--------------|
| Female thread A | = M3 |
| Height K | = 15 |
| Min distance to edge | = 4.0 |
| Outer diameter E | = 7 |
| Plate thickness | = 1.1 to 1.4 |
| Recommended bore diameter +0.05 | = 5.00 |
| Thread length | = 8.0 |